

**FREMONT
CLUB CHAIR**



FREMONT CLUB CHAIR

USD \$2895

Design

Joe Gibson

Dimensions

33" L x 30.75" W x 36" H

Seat Height - 16"

Weight

70 lbs.

Materials / Construction

- Domestic hardwood frame
- Maharam upholstery
- Commercial grade high density foam

Customization

We offer customizable upholstery & wood finishes.

- C.O.M. (customer's own material) available upon request.
- C.O.M. Yardage is 6 yds / Chair (C.O.M. Sample may be required)

Questions / Orders

Info@revolutiondh.com

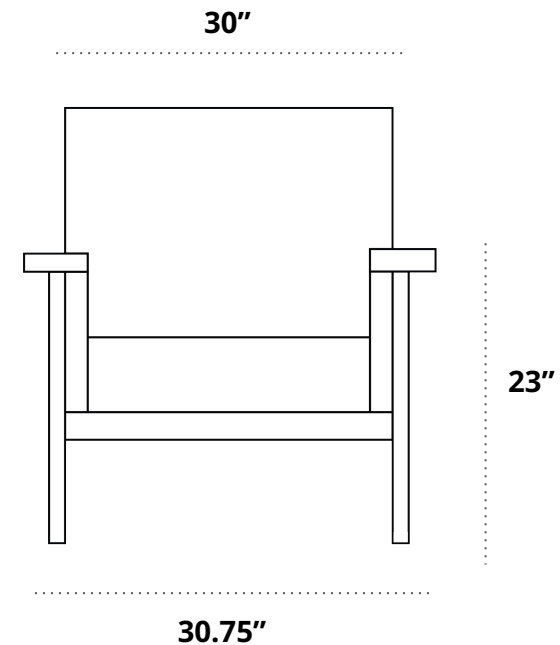
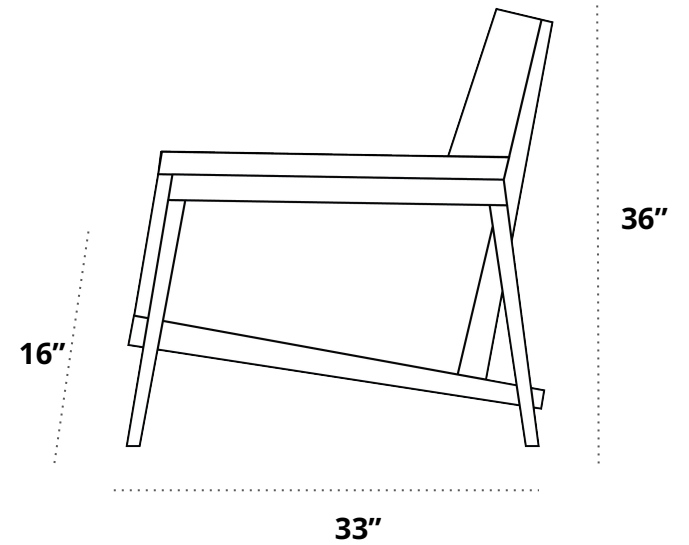

MATERIALS

WOOD OPTIONS

Wood samples are available upon request. Please send an email to info@revolutiondh.com with your address and requested samples.

We strive to maintain consistency in appearance in every product we make. However, wood is a natural material and can vary in tone, color and grain from tree to tree and piece to piece. No two pieces will be exactly the same, meaning every piece of furniture we produce is subtly unique.

Our wood is finished with a durable, solvent free, low VOC Hardwax oil.

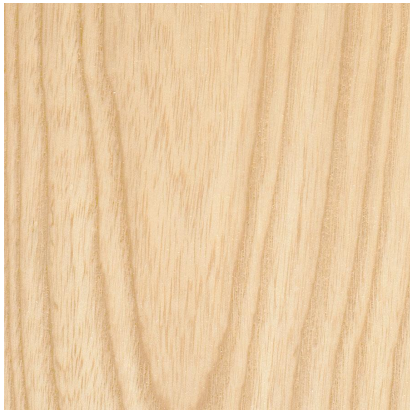

Ash
- Interior

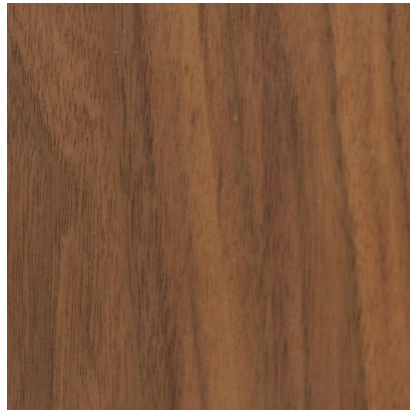

Walnut
- Interior

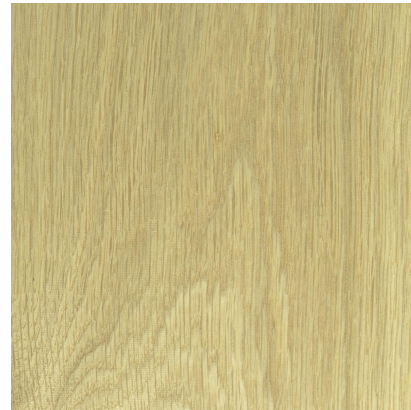

White Oak
- Interior / Exterior



Teak
- Interior / Exterior

MATERIALS

POWDER COATING - RAL colors



RAL 1000 49/15200



RAL 1019 49/13660 • 38/15019



RAL 2008 49/24340



RAL 3014 49/31080



RAL 4008 49/32280



RAL 5014 49/42320



RAL 1001 49/15190 • 38/15001



RAL 1020 49/22500 • 38/20020



RAL 2009 49/24360



RAL 3015 49/33670



RAL 4009 49/34740



RAL 5015 49/42330



RAL 1002 49/22590 • 38/20002



RAL 1021 49/22280

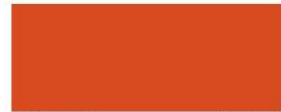

RAL 2010 49/24520

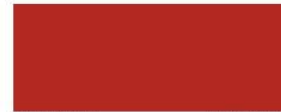

RAL 3016 49/31980



RAL 4010 49/40490



RAL 5017 49/40760 • 38/40017



RAL 1003 49/22580



RAL 1023 49/22490 • 38/20023



RAL 2011 49/24580



RAL 3017 49/31060



RAL 5000 49/42200



RAL 5018 49/41140 • 38/40020



RAL 1004 49/22570



RAL 1024 49/22480 • 38/20024



RAL 2012 49/24690



RAL 3018 49/31050



RAL 5001 49/42210



RAL 5019 49/42360 • 38/40019



RAL 1005 49/22560



RAL 1027 49/22470



RAL 3000 49/33120



RAL 3020 49/31040



RAL 5002 49/42220



RAL 5020 49/44270 • 38/40018



RAL 1006 49/22550



RAL 1028 49/22460



RAL 3001 49/31120

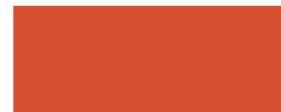

RAL 3022 49/33700



RAL 5003 49/42230



RAL 5021 49/41190 • 38/40021



RAL 1007 49/22540



RAL 1032 49/22450



RAL 3002 49/31110



RAL 3027 49/33660



RAL 5004 49/42240 • 38/40004



RAL 5022 49/42390



RAL 1011 49/15180



RAL 1033 49/22240



RAL 3003 49/31100



RAL 3031 49/34730



RAL 5005 49/43190



RAL 5023 49/44650



RAL 1012 49/22530



RAL 1034 49/23910



RAL 3004 49/33900



RAL 4001 49/43160



RAL 5007 49/42250 • 38/40007



RAL 5024 49/44660



RAL 1013 49/11280 • 38/10013



RAL 1037 49/20096



RAL 3005 49/31900



RAL 4002 49/31030



RAL 5008 49/42260 • 38/40008



RAL 6000 49/53160 • 38/50000



RAL 1014 49/15170 • 38/15014



RAL 2000 49/24570



RAL 3007 49/31910



RAL 4003 49/32270



RAL 5009 49/42270



RAL 6001 49/52900 • 38/50005



RAL 1015 49/15320 • 38/15015



RAL 2001 49/24560



RAL 3009 49/31920



RAL 4004 49/31020



RAL 5010 49/42280



RAL 6002 49/52890



RAL 1016 49/22520 • 38/20016



RAL 2002 49/24550



RAL 3011 49/31090



RAL 4005 49/42780

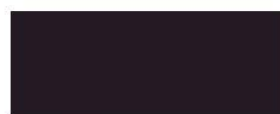

RAL 5011 49/43180 • 38/40011



RAL 6003 49/52880 • 38/50003



RAL 1017 49/22510



RAL 2003 49/24540



RAL 3012 49/31940 • 38/30012



RAL 4006 49/32090



RAL 5012 49/43170



RAL 6004 49/50980 • 38/50004



RAL 1018 49/21830



RAL 2004 49/24530



RAL 3013 49/31950



RAL 4007 49/32540



RAL 5013 49/42310 • 38/40013



RAL 6005 49/50670 • 38/50002

MATERIALS

FABRIC - Hallingdal by Kvadrat

460760-590 / 70% Wool, 30% Rayon / 100,000 cycles, Martindale method

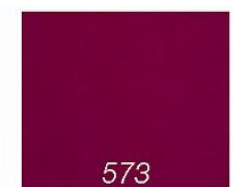
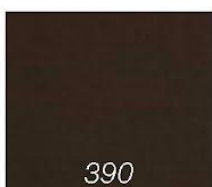
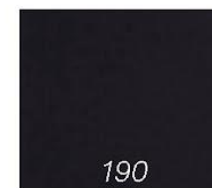
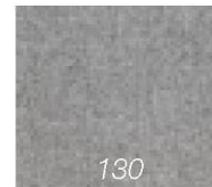
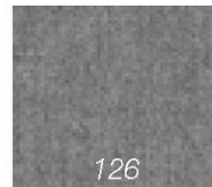
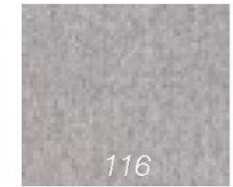
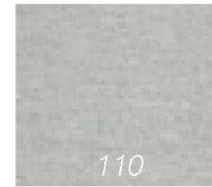
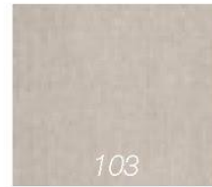
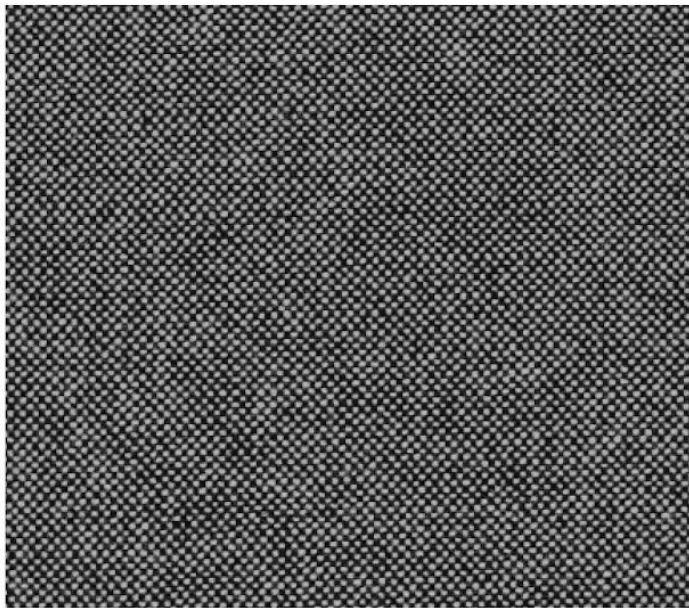

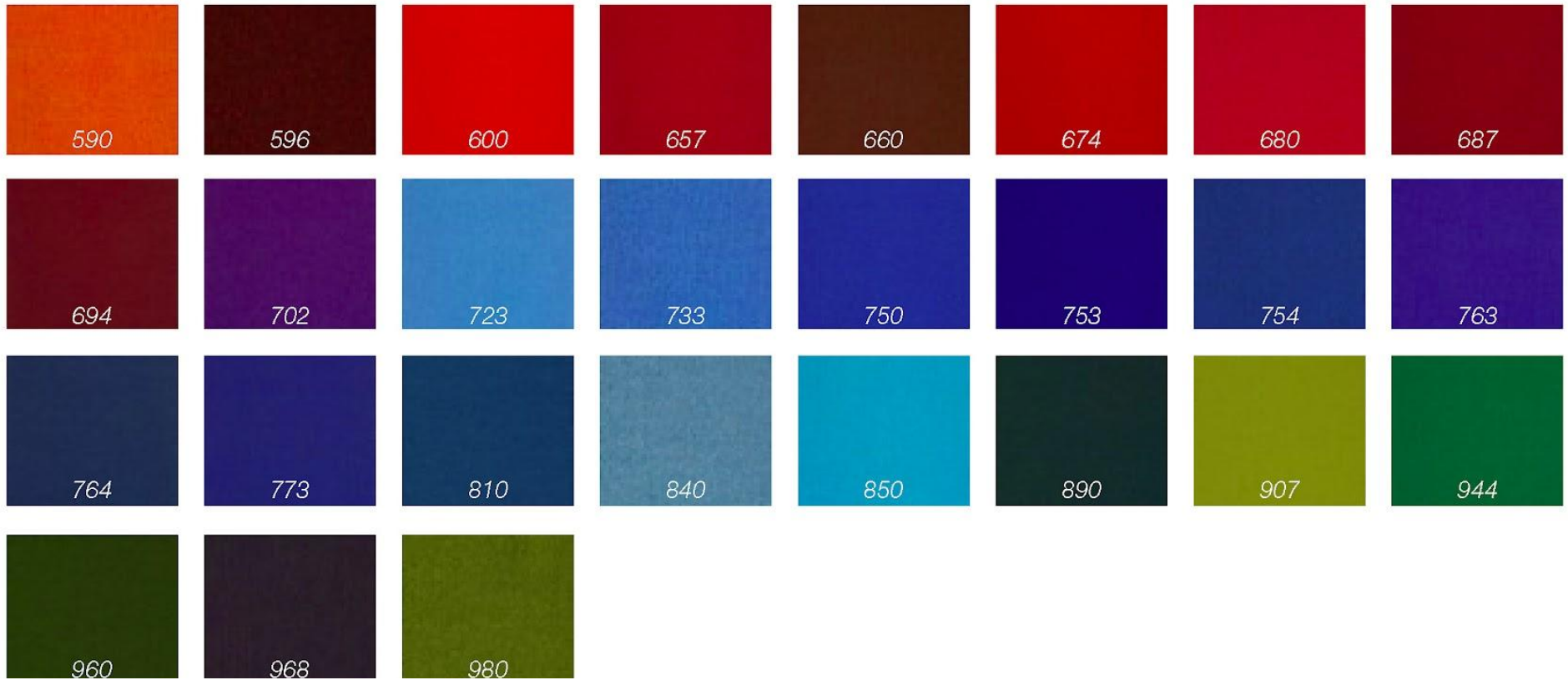

MATERIALS

FABRIC - Divina Melange by Kvadrat

460830-671 / 100% Wool / 45,000 cycles, Martindale method

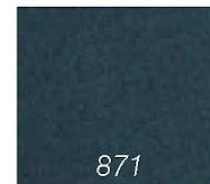
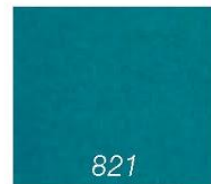

MATERIALS

FABRIC - Divina by Kvadrat

460730-886 / 100% Wool / 45,000 cycles, Martindale method



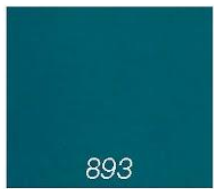
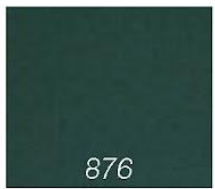
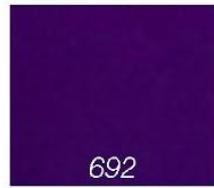
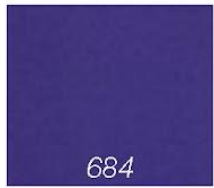

MATERIALS

FABRIC - Sunbrella Upholstery Canvas

100% Sunbrella Acrylic

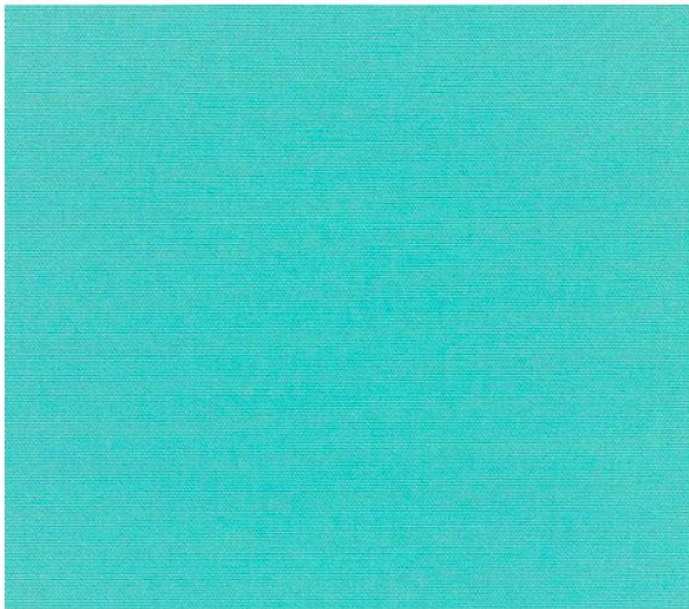

Plum



Polar Blue

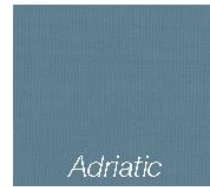

Adriatic



Riviera Blue

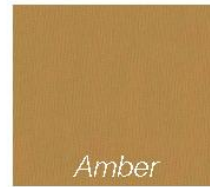

Amber



Sand



Beige

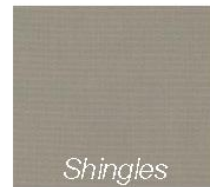

Shingles



Pebble

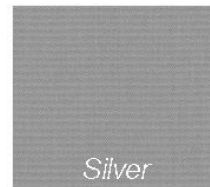

Silver



Ardoise SJA

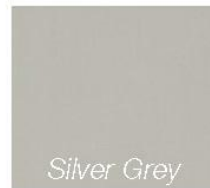

Silver Grey

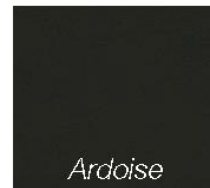

Ardoise



Snowy



Aruba

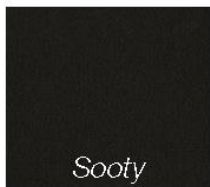

Sooty



Chine



Taupe SJA



Black

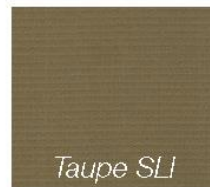

Taupe SLI



Blue Storm



Taupe Chine

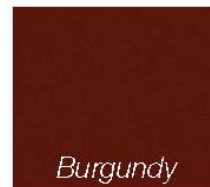

Burgundy



True Blue

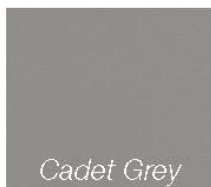

Cadet Grey

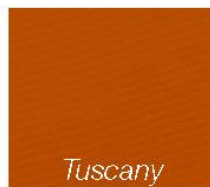

Tuscany

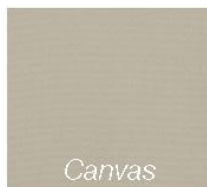

Canvas



White Sand



Air Blue



Antique Beige

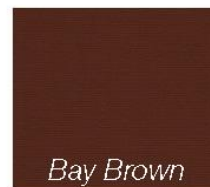

Bay Brown



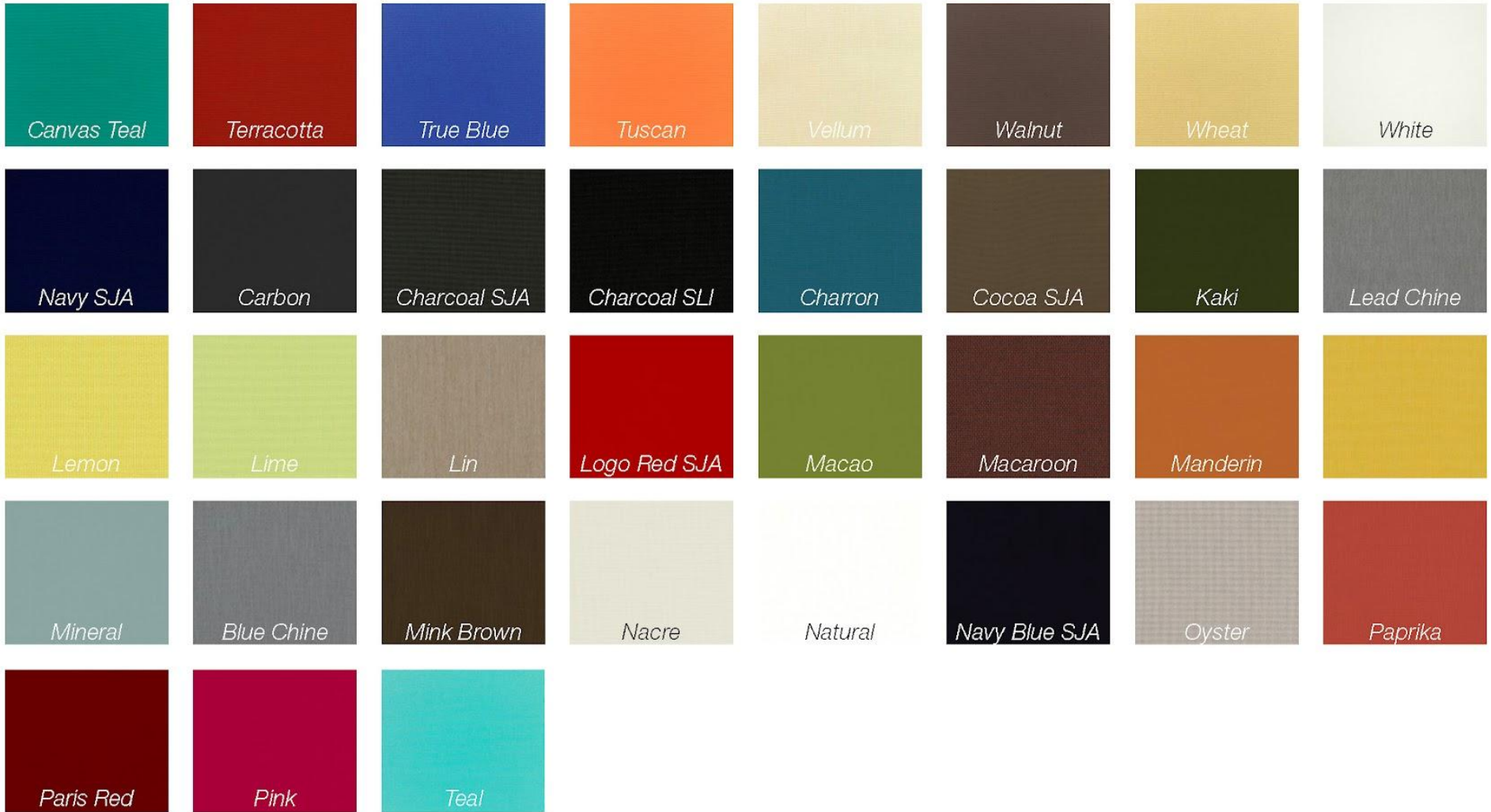

FAQ & TERMS

Ordering / Questions

For orders and any questions you may have please email us at info@revolutiondh.com

Trade Discount

We offer a trade discount to interior designers, procurement companies, architects and other members of the design trade. Please reach out to info@revolutiondh.com for more information.

Business/License number may be required at our discretion.

Lead Time

Our standard lead time is 8-10 weeks from receipt of deposit. In many cases we are able to provide rush orders for an additional fee. If your order is time sensitive please get in touch and we will do our best to accommodate.

Payment

We require a non-refundable 50% deposit on all orders over \$5000, with the remainder due upon delivery. For orders \$5000 and under full payment is due at time of purchase.

We accept payment by check, ACH (via Quickbooks), and Credit Card (with a 3% processing fee).

Our mailing address is:

Revolution Design House

PO Box 14555

Portland OR, 97293

Returns

Each piece of our furniture is made to order and customised with the colors, wood and fabric of your choice, and as such we are unable to accept returns or exchanges after an order is placed.

Shipping

Our furniture ships securely wrapped, boxed and palletized via our LTL carrier. We offer both domestic & international shipping.

Domestic shipping costs can be expected to add between 10-20% to the cost of the order.

For international shipping please send us an email at info@revolutiondh.com and we will send you a quote.

For all shipping quotes please provide your name, delivery address, and contact phone number.

Contract Grade

We take pride in our customer relationships and quality of our furniture. Our shop can accommodate orders of any scale and we enjoy working directly with our clients to create furniture that fits the needs of any project.

Our furniture is designed and built to withstand the traffic of commercial environments. Our metal frames are welded and powder coated, our wood construction has durable tenoned joinery and our graded in upholstery fabrics are all commercial grade.

CUSTOMIZATION

At Revolution Design House we strive to create furniture that fits the needs of any project. We offer a wide range of powder coating colors, upholstery options and wood finishes across our furniture line. We aim to provide our clients the choices they need to create unique pieces. If your project requires options outside of our catalog we are more than happy to further customize our furniture to fit your needs.

For all customization inquiries please send an email to info@revolutiondh.com

C.O.M.

We offer upholstery with C.O.M (Customers Own Material) on all of our upholstered pieces. We are happy to use your provided fabric however we may require a sample to ensure compatibility if it is something we have not worked with before.

Wood Finishes

If you are interested in our furniture, but prefer a wood not available in our catalog, please reach out and we will be happy to work with you to create a piece to your specifications. Additional costs can be expected for custom wood finishes.

Powder Coating

For custom colors or specialty finishes not available in our catalog please send us a sample or product number/description in order to ensure compatibility and availability. Additional costs can be expected for custom colors & finishes.

Dimensions

We are able to customize the dimensions of our furniture to meet the requirements or desires of many projects. Whether it is turning a chair into a loveseat or changing seat height we are happy to accommodate. Please send us an email with your desired dimensions and we send you a quote.

CARE INSTRUCTIONS

UPHOLSTERY

Maintenance of upholstery textiles

Regular cleaning is important in order to keep the upholstery textile looking its best and to prolong its life. Dust and dirt wear down the textile and also reduce its fire-retardant properties.

Normal cleaning

Vacuum frequently, ideally every week, at half power where appropriate. Wipe upholstery fabrics made from polyurethane with a dry or moist cloth. May also be vacuum cleaned with a soft brush.

Stain removal

If you act quickly, it is not difficult to remove spills and prevent stains from forming. However, we cannot guarantee complete stain removal. First, scrape off any liquids or hardened residues with a spoon or a scoop before you proceed. Any loose particles must be vacuum cleaned before further cleaning. Liquids must be soaked up with an absorbent napkin or cloth.

Remove non-greasy stains by carefully dabbing with a lintfree cloth or sponge wrung out in warm water. Edge marks can be avoided by dabbing gently in circular motions towards the centre of the stain with a clean lint-free cloth. Remove greasy stains by using appropriate detergents or solvents. In all cases, we recommend to test stain-removal agents on an inconspicuous area first, to see if there is any effect on the cover.

Make sure to dry the fabric fully before use. It may also be necessary to use a hairdryer to avoid leaving edge marks. This applies especially to microfibre textiles.

These tips are purely recommendations and cannot guarantee complete stain removal. In all cases, we recommend contacting a professional dry cleaning. In order to ensure satisfactory results, particularly for large stains, we recommend to contact a professional dry cleaner. It is important to state whether the stain has already undergone treatment.

Due to excess dye in jeans, dark jeans may leave stains on textiles; washing and cleaning may not always lead to satisfying results. Stains from jeans on polyurethane products may be removable by using a rubber.

Warning - do not rub the material hard because this could result in loss of colour or potentially damage the nap.

Be careful when using solvents; these could dissolve the upholstery materials beneath. Never use un-concentrated detergents or bleach, ammonia or soap intended for hard surfaces.

Divina family

Removing stains from textiles in the Divina family can be difficult, as the fabric is being pressed after fulling in order to achieve the felt-like surface.

Particularly on new woollen covers, the fibres will slightly rise when the fabric becomes moist. The moist area will appear as a darker stain. The textile cannot be pressed again, however, it is possible to reduce the discolouration by spraying water over the entire furniture piece. When using the furniture and at normal humidity levels, the wool fibres will rise and potential stains will become less visible..

Cleaning and impregnation

It is usually recommended that upholstered furniture with normal commercial use should be cleaned 2–3 times a year. Upholsteries in private households usually need less frequent cleaning.

Textiles made from cotton are often impregnated. However, the treatment is not permanent and can be worn off during usage or cleaning. We therefore suggest to re-impregnate the textile after cleaning.

We do not recommend impregnation of woollen upholstery fabrics, as wool itself is dirt-repellent. Impregnation of fabrics made from 100% Trevira CS should be avoided since it decreases the fabric's permanent flame-retardant attributes.

Regular maintenance and cleaning removes dirt before it settles in the fabric and damages the fibres. Appropriate maintenance and regular cleaning can prolong the textile's life cycle and reduce costs for renovation and repair, replacement and disposal.

In order to ensure satisfying cleaning results, we recommend to contact a professional cleaning institute. Employing pHneutral carbon dioxide solutions for cleaning is recommended because this method avoids the use of soap. A professional cleaning institute may also assist in working out maintenance schedules, which ensure that the fabrics are maintained properly so that a good indoor climate and a maximum duration of the upholsteries are achieved.

Use washing detergent designated for coloured textiles and obey the dosage. Wash the fabric inside-out and load only half on the machine. Spin-dry the fabric with decreased speed. The covers should be dried while suspended and mounted or applied while still slightly damp in order to ease the process. (via <https://kvadrat.dk/care-and-maintenance/upholsteries>)

WOOD

Wood finishes can be cleaned using a soft rag with warm soapy water or simple green. Do not use abrasive cleaners or applicators on wood finishes.

POWDER COATING

Powder-coating can be cleaned using a soft rag with warm soapy water or simple green. Do not use abrasive cleaners or applicators on powder-coating.

WARRANTY

OUR COMMITMENT TO YOU

Revolution Design House warrants to the buyer, and only to the original buyer, that goods shall be free of defects in material and /or workmanship attributable to manufacturer (except fabrics and leathers and with the limitations listed below) for a period of 2 years from date of shipment to buyer. Warranty is subject to normal use under normal conditions. Seller shall, upon prompt written notice, repair or replace, at its option and costs, the affected part or parts. Replacement goods will be released to the same delivery point of the original items that are being replaced. No Goods may be returned by the Buyer without Seller's prior written authorization. THE REPAIR OR REPLACEMENT OF DEFECTIVE GOODS CONSTITUTES REVOLUTION DESIGN HOUSE'S ENTIRE OBLIGATION. THERE ARE NO OTHER WARRANTIES, EXPRESSED OR IMPLIED, INCLUDING ANY WARRANTY OR MERCHANTABILITY OR FITNESS FOR A PARTICULAR PURPOSE.

Revolution Design House shall in no event be liable for incidental or consequential damages. All claims for seller's failure to comply with this warranty shall be governed by the provisions of this paragraph.

This warranty does not apply to:

- Goods subjected to misuse or abuse
- Fabrics and leather Goods (where the original warranty provided by the manufacturers of these materials shall solely apply)
- Damage caused by a carrier or installer
- Normal wear and tear or acts of omissions of parties other than the Seller (including fabric treatments, user modifications and improper installation)
- Any third party materials applied to Goods
- Dramatic temperature variations or exposure to unusual conditions during use, installation, transportation or storage
- Changes in surface finishes including colorfastness due to aging or exposure to light (including sunlight)
- Damage resulting from exposure to extreme weather or extreme atmospheric conditions
- Any faults relating to the Buyer-supplied material for COM or customized Goods
- Natural weathering of wood both interior and exterior due to sunlight or moisture